

Forme costruttive di serie



forma B



forma S



forma D

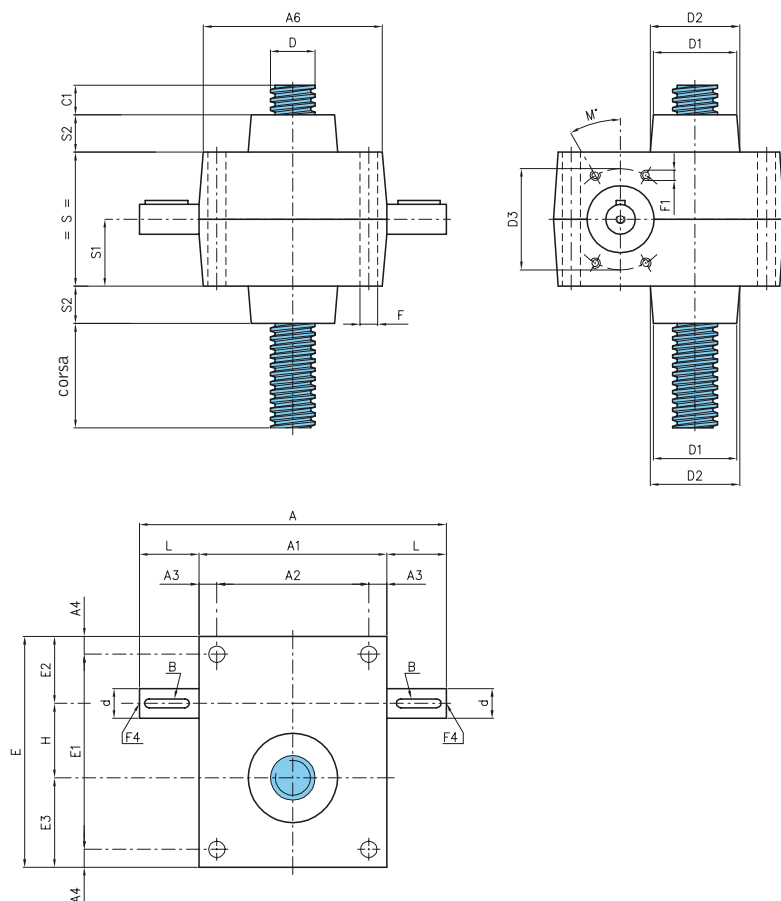

Modelli TP - XTP*

Grandezza	420	630	740
A	150	206	270
A1	100	126	160
A2	80	102	130
A3	10	12	15
A4	7,5	12	15
A6	99	125	159
B	4x4x20	6x6x30	8x7x40
C1	15	20	25
d Ø j6	12	20	25
D Ø	20x4	30x6	40x7
D1 Ø	43	59	69
D2 Ø	44	60	70
D3 Ø	52	56	80
E	100	155	195
E1	85	131	165
E2	32,5	45	50
E3	37,5	60	75
F Ø	9	11	13
F1	M6x10	M6x10	M8x10
F4	M5x10	M6x12	M8x15
H	30	50	70
L	25	40	55
M [°]	30	45	30
S	70	90	120
S1	35	45	60
S2	20	25	35

* Modello XTP: versione in acciaio inossidabile



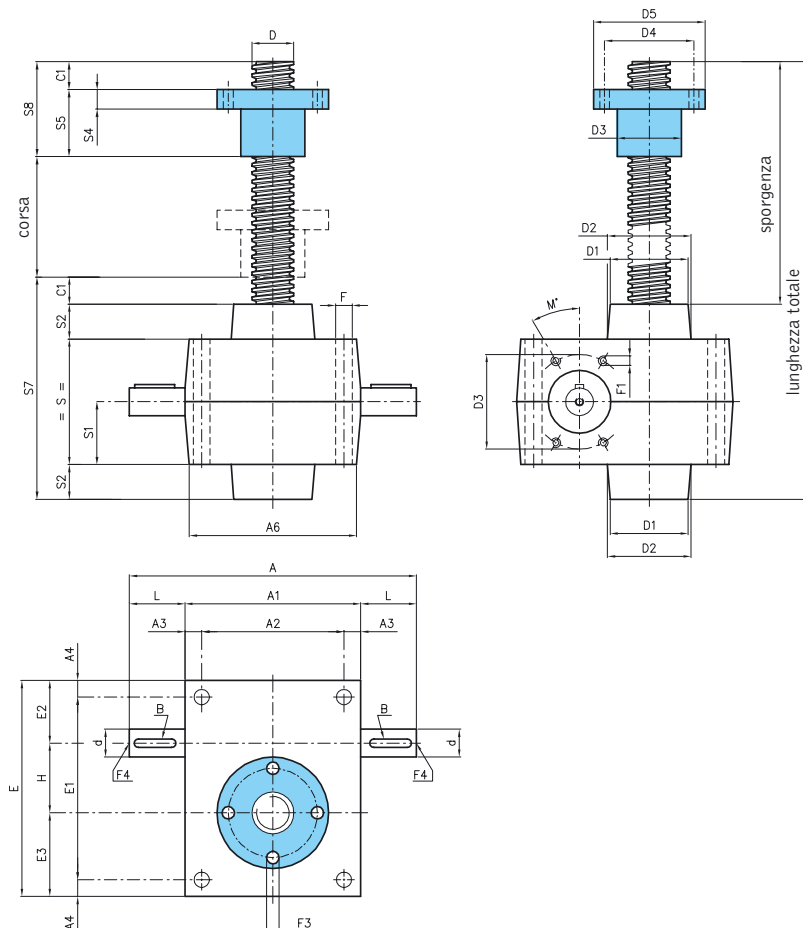

Forme costruttive di serie



forma B



forma S



forma D

Modelli TPR - XTPR*

Grandezza	420	630	740
A	150	206	270
A1	100	126	160
A2	80	102	130
A3	10	12	15
A4	7,5	12	15
A6	99	125	159
B	4x4x20	6x6x30	8x7x40
C1	15	20	25
d Ø j6	12	20	25
D Ø	20x4	30x6	40x7
D1 Ø	43	59	69
D2 Ø	44	60	70
D3 Ø	52	56	80
D4 Ø	45	64	78
D5 Ø	60	80	96
E	100	155	195
E1	85	131	165
E2	32,5	45	50
E3	37,5	60	75
F Ø	9	11	13
F1	M6x10	M6x10	M8x10
F3 (4 fori)	7	7	9
F4	M5x10	M6x12	M8x15
H	30	50	70
L	25	40	55
M [°]	30	45	30
S	70	90	120
S1	35	45	60
S2	20	25	35
S4	12	14	16
S5	45	48	75
S7	125	160	215
S8	60	68	100

* Modello XTPR: versione in acciaio inossidabile